

REVISION RECORD			
LTR	ECO NO:	APPROVED:	DATE:

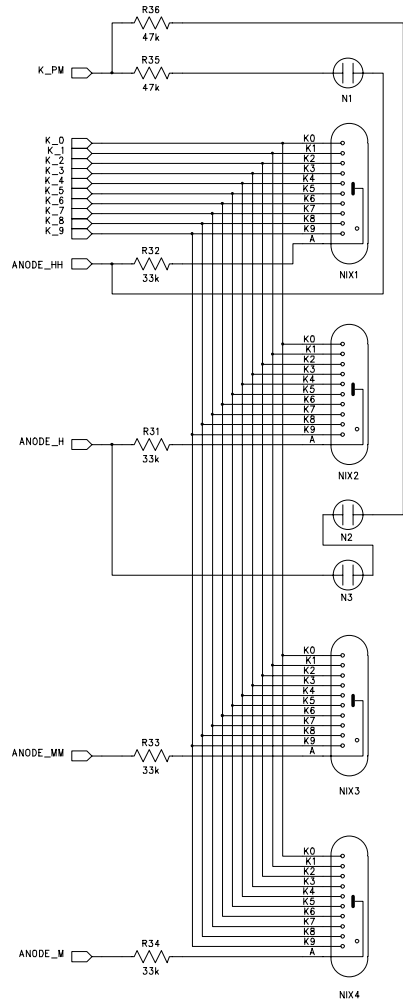

COMPANY: OTG

TITLE: NIX-IN-17

DRAWN: H. Carl Ott	DATED: OCT-2005
CHECKED:	DATED:
QUALITY CONTROL:	DATED:
RELEASED:	DATED:

CODE:	SIZE: C	DRAWING NO:	REV:
SCALE:		SHEET: 2 OF 2	